

## Product Description

ATEK853P3 is a power divider covering LF to 9 GHz frequency range. RF ports are DC coupled which allows operation down to DC.

ATEK853P3 provides flat loss over its frequency range. This allows users to easily realize wideband receivers with high data rate.

Divider is housed in compact 3x3 mm low cost SMD package, input and output ports are matched to 50 ohms internally.

Evaluation Board, bare die, custom package, and module options are available upon request.

## Product Features

- Frequency Range: LF - 9 GHz
- Loss: 1 dB (In addition to 3 dB)
- Amplitude Imbalance: 0.1 dB
- Phase Imbalance: 0.7 degrees
- 3x3 mm compact size

## Applications

- Wideband Receivers
- Telecommunication
- Test and Measurement
- SATCOM
- SDR

## Functional Block Diagram

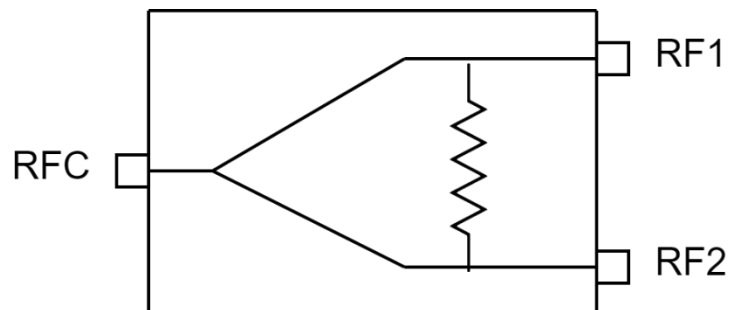

## Electrical Specifications

Conditions unless otherwise specified: Typical, T = 25 C, CW.

Parameter		Min	Typ	Max	Units
Operational Frequency Range		LF		9	GHz
Insertion Loss	0.01 GHz		3.8		dB
	1 GHz		3.8		
	2 GHz		3.7		
	4 GHz		3.6		
	9 GHz		4.7		
Isolation	0.01 GHz		4.4		dB
	1 GHz		6.5		
	2 GHz		14.5		
	4 GHz		19		
	9 GHz		16		
Input Return Loss			-14		dB
Output Return Loss			-17		dB
Operating Temperature		-40		85	°C

## Typical Performance Plots

Conditions unless otherwise specified: Typical, T = 25 C, CW.

Insertion Loss

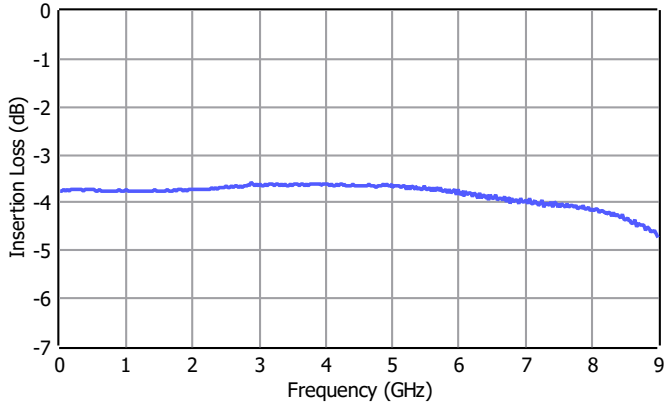

Isolation

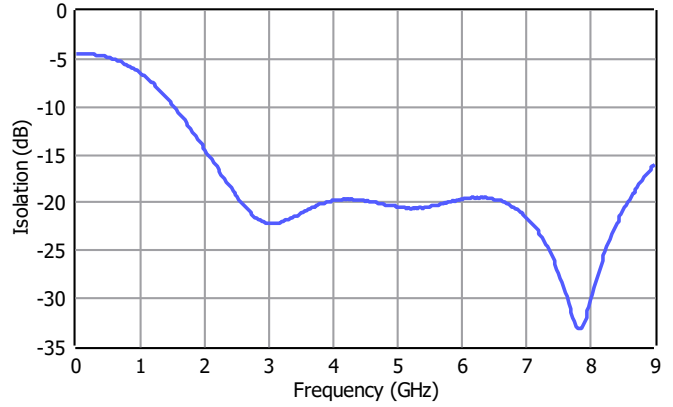

Amplitude Imbalance

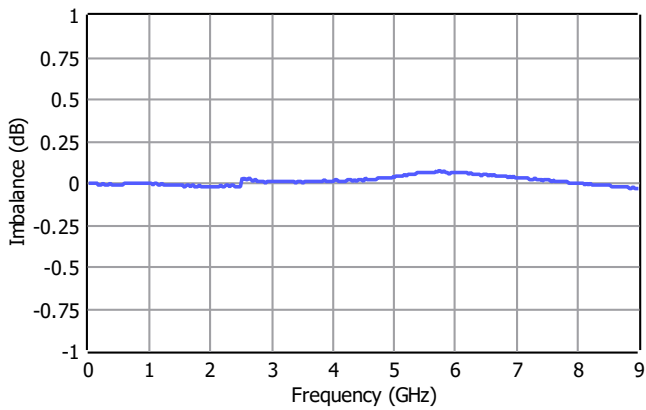

Phase Imbalance

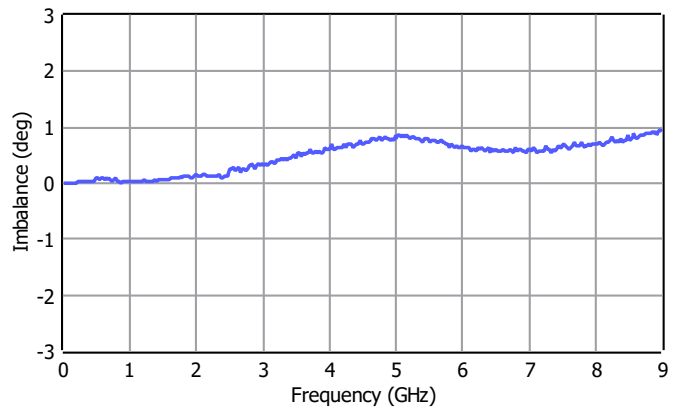

Return Loss

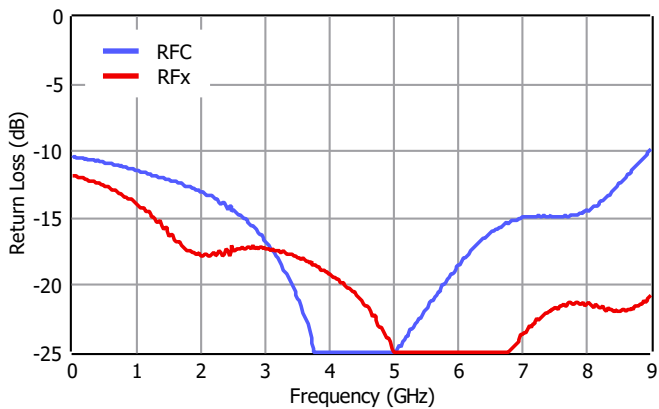

## Pin Description

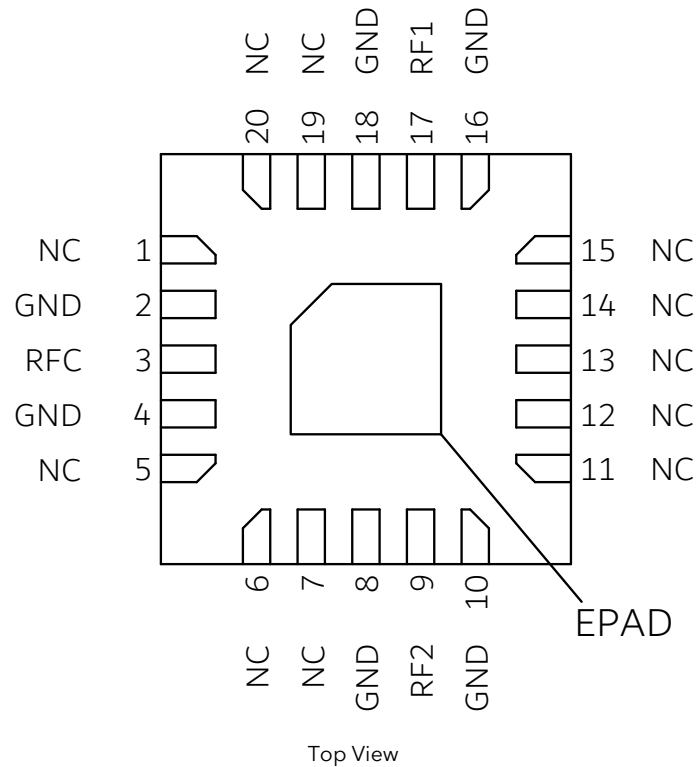

Pin Number	Pin Name	Description
3	RFC	RF input/output pin.
17	RF1	RF input/output pin.
9	RF2	RF input/output pin.
1, 5-7, 11-15, 19, 20	NC	These pins are not internally connected. Can be grounded on the PCB.
2, 4, 8, 10, 16, 18	GND	Ground.
21	EPAD	Exposed Pad on the bottom of the package should be connected to ground with multiple number of vias to reduce the inductance to the GND.

## Applications Information

Signal entering from RFC is divided into 2, then delivered to RF1 and RF2 pins.  
Typical application schematic to operate the power divider is given below.

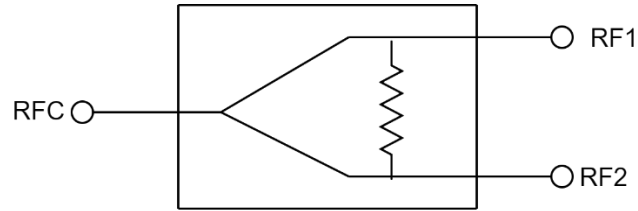

Insertion loss, isolation and return loss data are taken with probe PCB measurements. Amplitude and phase imbalance data are taken with connectorized evaluation board measurements, to generate data shown in this document.

The NC pins of the power divider are connected to the GND on the PCB used to generate the plots shown in this document.

## Absolute Maximum Ratings

Parameter	Value/Range
Supply Voltage (Vdd)	TBD
RF Input Power	TBD
Storage Temperature	-55 to +125°C

Operation of this device outside the parameter ranges given above may cause damage. These conditions should not be applied simultaneously.

## Mechanical and Marking Information

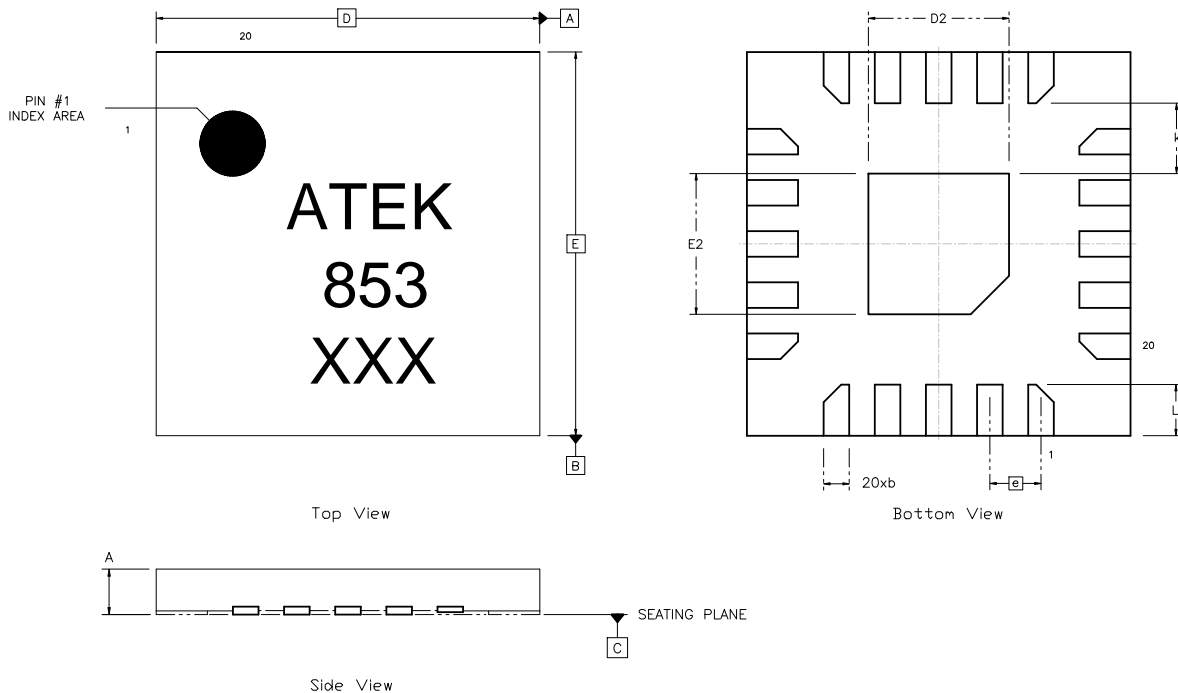

NOTES:  
1) ALL DIMENSIONS IN MM

SYMBOL	MIN	MAX	SYMBOL	MIN	MAX
A, V	0.80	1.00	E2	1.00	1.20
b	0.15	0.25	e	0.40	BSC
D	3.00	BSC	k	0.20	-
D2	1.00	1.20	L	0.35	0.45
E	3.00	BSC			

## Handling Precautions



Caution!  
ESD-Sensitive Device  
Handle Accordingly

## Contact Information

For the latest specifications, additional product information, support, and sales.

Web: [www.atekmidas.com](http://www.atekmidas.com)

Tel: +90-212-483-71-67

Email: [support@atekmidas.com](mailto:support@atekmidas.com)

## Notice

This document and its contents are property of ATEK MIDAS. ATEK MIDAS has the right to change the document at any time without notice. ATEK MIDAS distributes this document as a service to its customers. ATEK MIDAS supports its customers to help them create market leader products. Customer is responsible from choosing the product and the configuration the product. This document is provided `as is` and does not provide any warranty.

Customer is responsible for the usage of this document, the information provided in the document and the usage of products. ATEK MIDAS shall have no responsibility from the customer products, customer applications and doings of customers.

## Revisions

Revision No	Revision Date	Revision Reason	Section / Page No
1.0	23.10.2023	Initial Release	
1.1	06.05.2024	Format and Content Fixed	