

## Product Description

ATEK352N4 is a wideband voltage variable attenuator housed in 4x4 mm surface mount package. Attenuator operation range covers 2-40 GHz. Usable band high frequency goes down below to kHz region and up to 40 GHz.

RF input outputs are matched to 50 ohms internally.

Evaluation Board, bare die, custom package, and module options are available upon request.

## Product Features

- Frequency Range: 2 - 40 GHz
- Insertion Loss: 1.8 dB at 18 GHz
- Attenuation Range: 54 dB at 18GHz
- IIP3: 32 dBm at 18 GHz
- 4x4 mm SMD Package

## Applications

- Wideband Receivers
- Telecommunication
- Test and Measurement
- SATCOM

## Functional Block Diagram

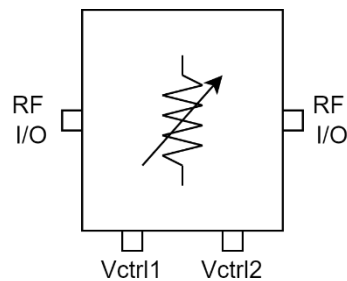

## Electrical Specifications

Conditions unless otherwise specified:  $V_{CTRL1} = V_{CTRL2}$ , Typical, T = 25 C, CW.

Parameter		Min	Typ	Max	Units
Operational Frequency Range		2		40	GHz
Insertion Loss	0.01 GHz		0.3		dB
	6 GHz		1.1		
	12 GHz		1.4		
	18 GHz		1.8		
	26.5 GHz		2.9		
	32 GHz		3.1		
	40 GHz		4.2		
Attenuation Range	0.01 GHz		21		dB
	6 GHz		41		
	12 GHz		53		
	18 GHz		54		
	26.5 GHz		50		
	32 GHz		44		
	40 GHz		38		
Input Return Loss			-13		dB
Output Return Loss			-13		dB
Input P1dB			20		dBm
Input IP3			32		dBm
Switching Speed	On		TBD		ns
	Off		TBD		
DC Supply Voltage ( $V_{CTRL1} = V_{CTRL2}$ )		-3		0	V
DC Supply Current ( $I_{CTRL1} + I_{CTRL2}$ )			3		mA
Operating Temperature		-40		85	°C

**Typical Performance Plots**

Conditions unless otherwise specified:  $V_{CTRL1} = V_{CTRL2}$ , Typical,  $T = 25\text{ C}$ , CW.

Attenuation States

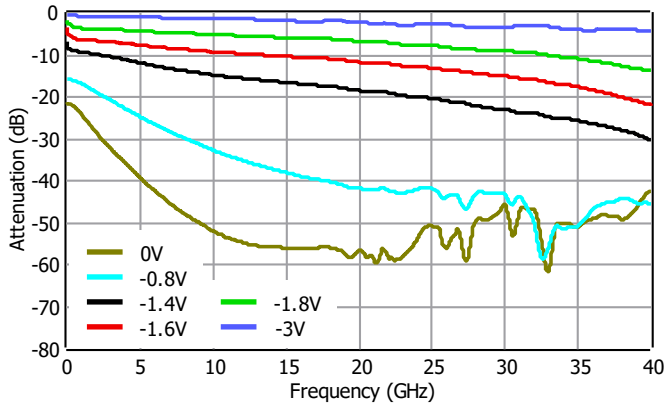

Insertion Loss

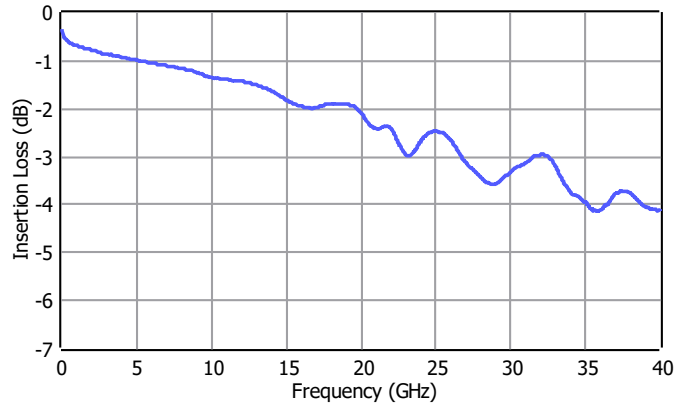

Normalized Attenuation

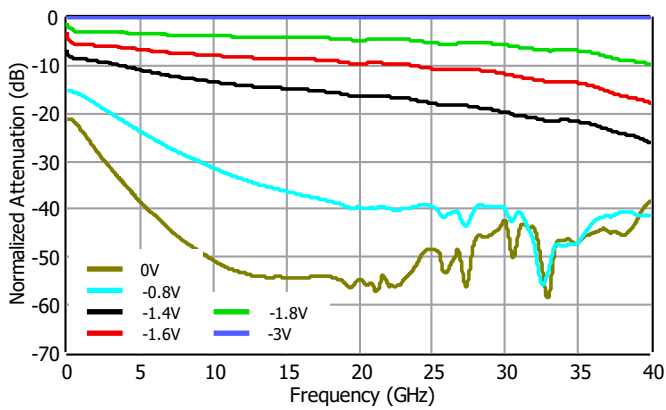

Input Return Loss

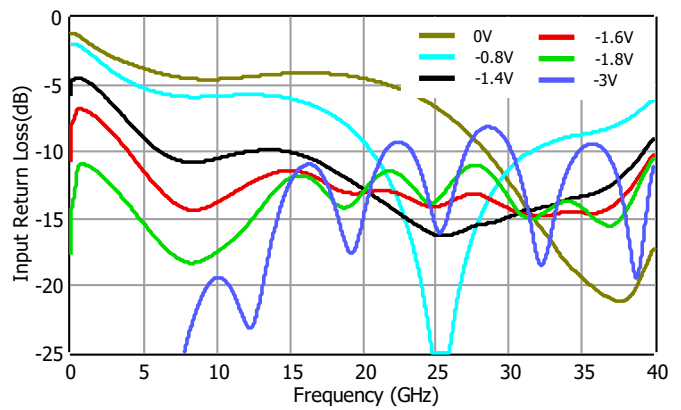

Output Return Loss

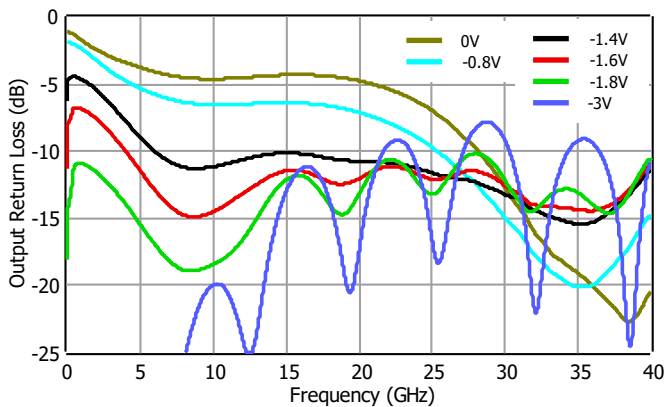

Attenuation Range

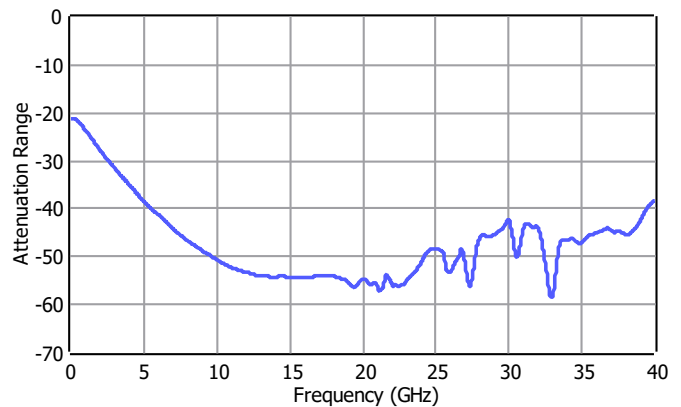

**Typical Performance Plots**

Conditions unless otherwise specified:  $V_{CTRL1} = V_{CTRL2}$ , Typical,  $T = 25\text{ C}$ , CW.

Attenuation vs Vctrl at 10 GHz

Attenuation vs Input Power

TBD

TBD

Input IP3 at  $V_{CTRL} = -3V$

Input IP3 vs  $V_{CTRL}$  at 10 GHz

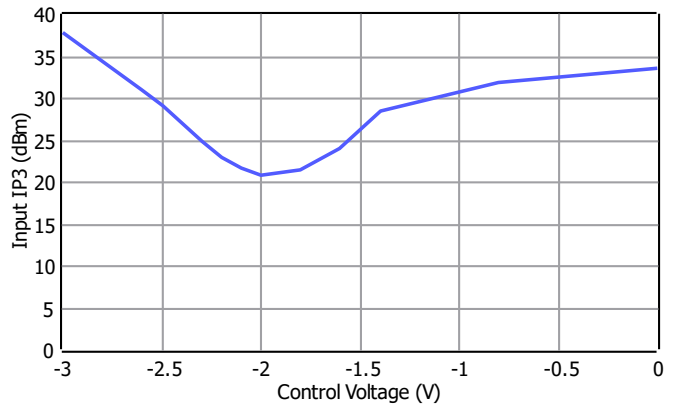
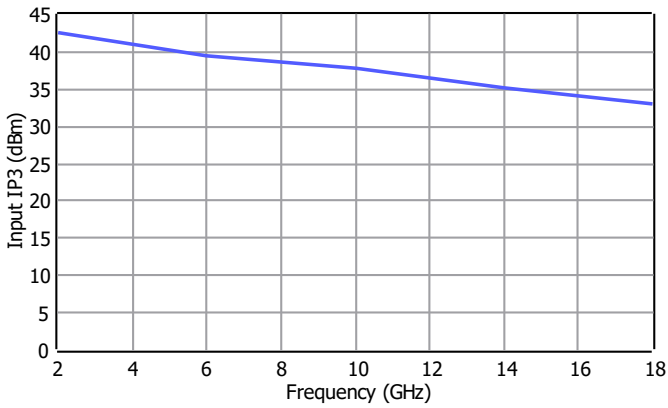

Input P1dB at  $V_{CTRL} = -3V$

Input P1dB vs Control Voltage at 10 GHz

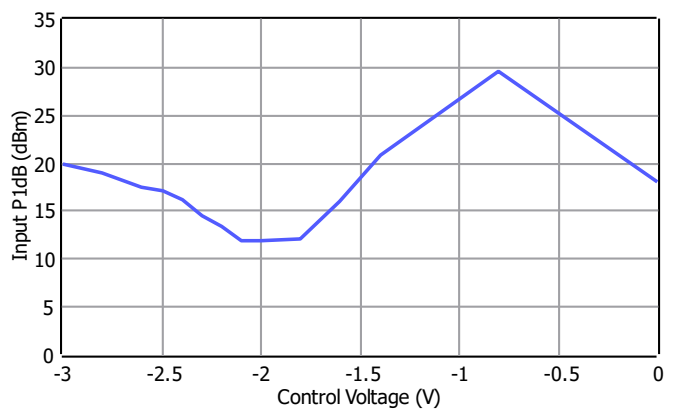
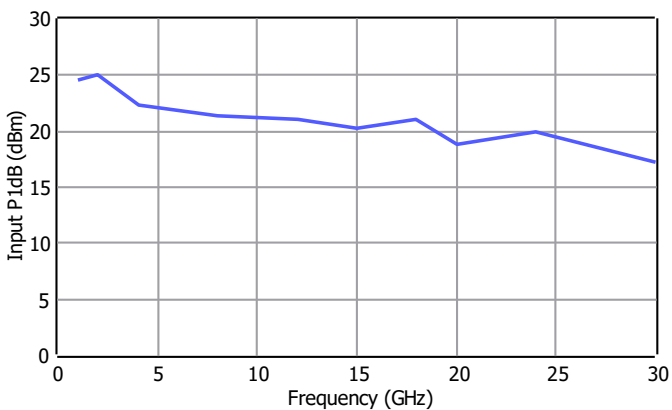

**Pin Description**

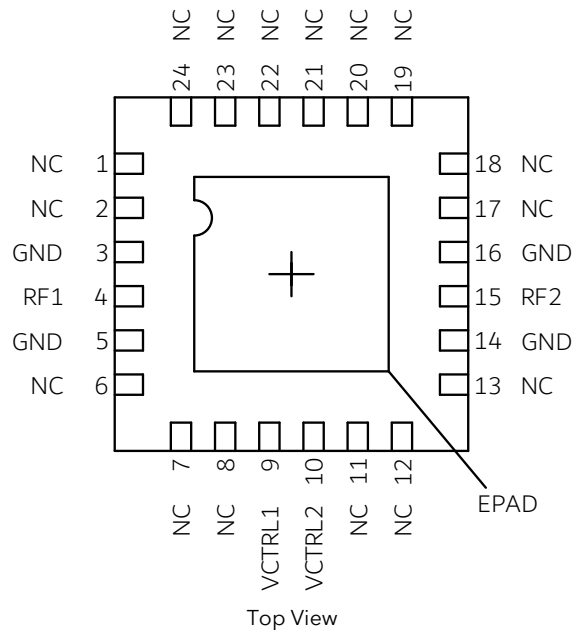

Pin Number	Pin Name	Description
4	RF1	RF input, output pin. If the DC voltage level on RF lines is not equal to 0 V, an external DC block capacitor is required.
15	RF2	RF input, output pin. If the DC voltage level on RF lines is not equal to 0 V, an external DC block capacitor is required.
9	VCTRL1	Control voltage pin.
10	VCTRL2	Control voltage pin.
1, 2, 6 - 8, 11- 13, 17 - 24	NC	These pins are not internally connected. Can be grounded on the PCB.
3, 5, 14, 16	GND	Ground.
25	EPAD	Exposed Pad on the bottom of the package should be connected to ground with multiple number of vias to reduce the inductance to the GND.

## Applications Information

Signal entering from RF IN goes to RF OUT with an attenuation.  
Typical application schematic to operate the amplifier is given below.

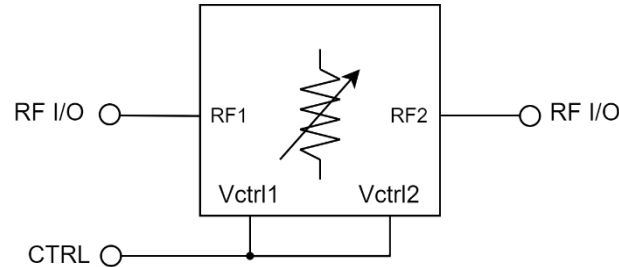

The attenuation level of the voltage variable attenuator is controlled through Vctrl1 and Vctrl2 pins. A voltage level in between -3 V to 0 V can be applied to those pins to set the attenuation level.

To filter out the ripples and unwanted signals on the external CTRL signal, a low pass filter in series R, shunt C configuration can be implemented on the Vctrl1 and Vctrl2 lines. Note that external RC filtering limits the attenuation state switching speed of the attenuator. If filtering the external CTRL signal is of no concern, then the attenuator can be operated without any additional external components.

Large signal datasheet plots are generated by connectorized evaluation boards (EVBs), PCB and connector losses are de-embedded. Small signal plots are generated by probing the RF lines with RF probes to eliminate the connector transition effects.

NC pins are connected to the GND on the EVBs used to generate the plots shown in this document.

## Absolute Maximum Ratings

Parameter	Value/Range
Supply Voltage (Vdd)	TBD
RF Input Power	TBD
Storage Temperature	-55 to +125°C

Operation of this device outside the parameter ranges given above may cause damage. These conditions should not be applied simultaneously.

## Mechanical and Marking Information

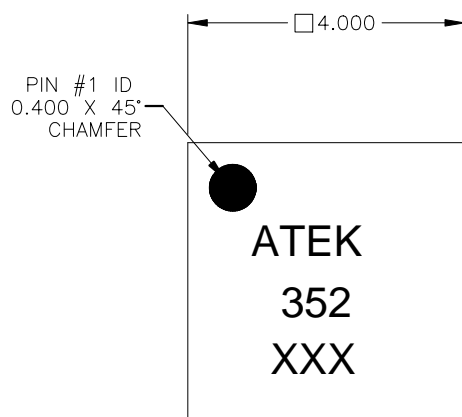

TOP VIEW

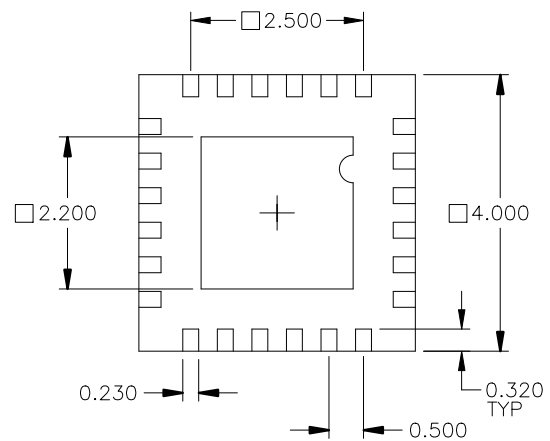

BOTTOM VIEW

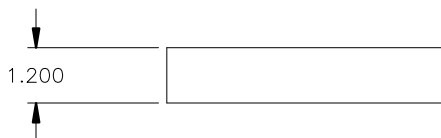

SECTION A-A

### NOTES

1. ALL DIMENSIONS IN MM

## Handling Precautions



Caution!  
ESD-Sensitive Device  
Handle Accordingly

## Contact Information

For the latest specifications, additional product information, support, and sales.

Web: [www.atekmidas.com](http://www.atekmidas.com)

Tel: +90-212-483-71-67

Email: [support@atekmidas.com](mailto:support@atekmidas.com)

## Notice

This document and its contents are property of ATEK MIDAS. ATEK MIDAS has the right to change the document at any time without notice. ATEK MIDAS distributes this document as a service to its customers. ATEK MIDAS supports its customers to help them create market leader products. Customer is responsible from choosing the product and the configuration the product. This document is provided `as is` and does not provide any warranty.

Customer is responsible for the usage of this document, the information provided in the document and the usage of products. ATEK MIDAS shall have no responsibility from the customer products, customer applications and doings of customers.

## Revisions

Revision No	Revision Date	Revision Reason	Section / Page No
1.0	20.09.2022	Initial Release	
1.1	15.09.2023	Plots Added	